

ADDRESS: _____

NOTES:

- 1/ FRESH WATER PIPE JOINTING METHOD: SOLDERING / COMPRESSION / OTHERS _____
(PLEASE SPECIFY)
- 2/ NO WATER PIPE TO BE EMBEDDED IN LOAD BEARING STRUCTURAL ELEMENTS
- 3/ ALL WATER PIPES WHICH COME INTO DIRECT CONTACT WITH CONCRETE TO BE PROTECTED WITH SUITABLE MATERIAL
- 4/ FRESH WATER PIPE USING COPPER TUBE $\varnothing 15 - \varnothing 28$
- 5/ FLUSHING WATER PIPE (TMF) USING U.P.V.C. $\varnothing 15 - \varnothing 50$
- 6/ ALL PIPEWORK BEFORE METER POSITION SHALL BE EXPOSED OR LAID IN A PROPER SERVICE DUCT
- 7/ THE PIPINGS WHICH SOLELY SERVE A PARTICULAR FLAT/UNIT SHOULD NOT RUN THROUGH OTHER FLATS/UNITS AS FAR AS PRACTICABLE

* A LOOSE JUMPER TYPE VALVE SHALL BE FITTED ON THE INLET OF THE WATER HEATER IF A NON-RETURN VALVE IS NOT INCORPORATED IN SUCH WATER HEATER, BUT THIS REQUIREMENT DOES NOT APPLY TO AN ELECTRIC WATER HEATER OF THE THERMAL STORAGE TYPE SATISFYING THE REQUIREMENTS STIPULATED IN THE HONG KONG STANDARD REQUIREMENTS FOR PLUMBING INSTALLATION IN BUILDINGS PARAGRAPHS 5.11

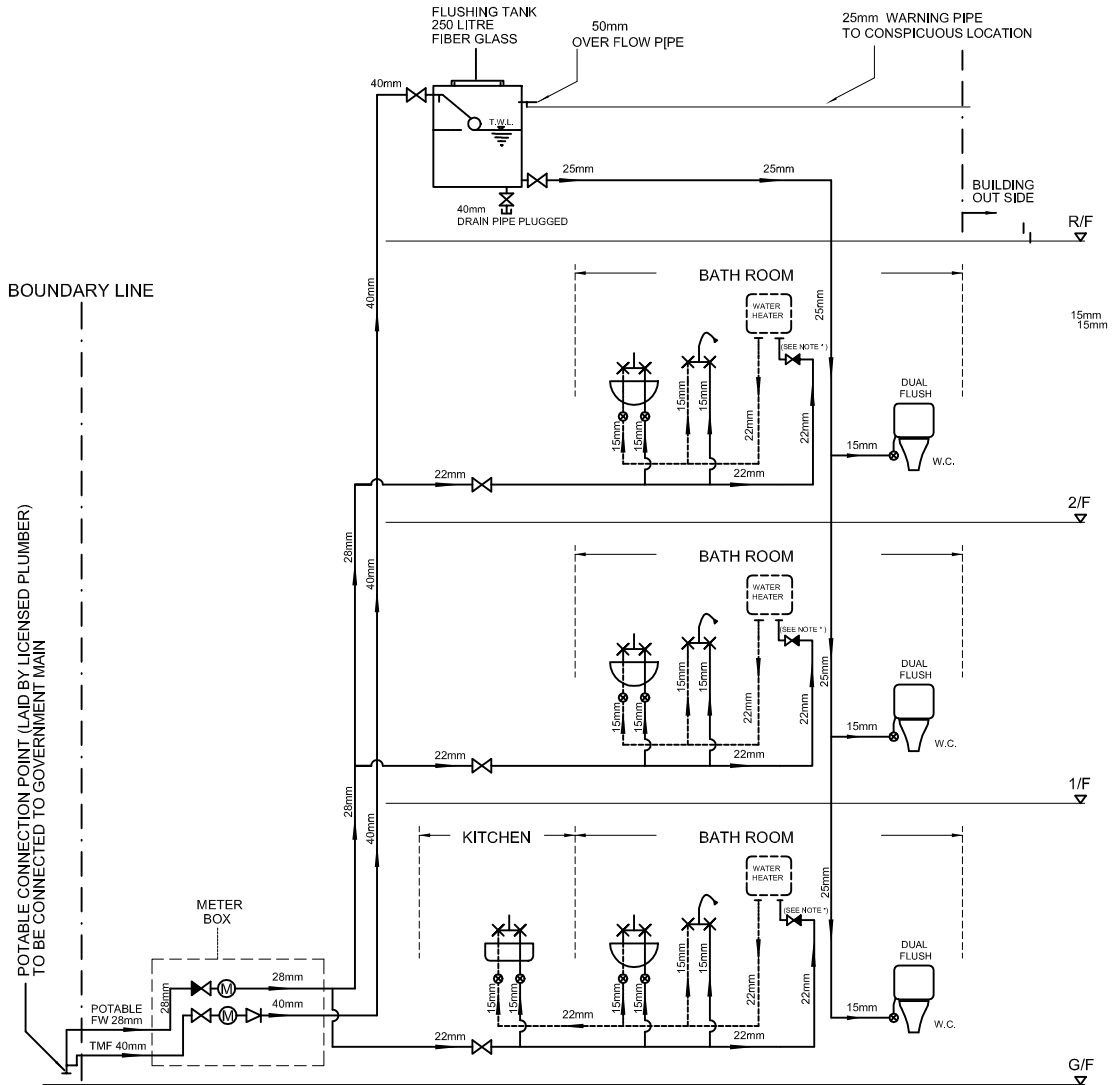

LEGEND:

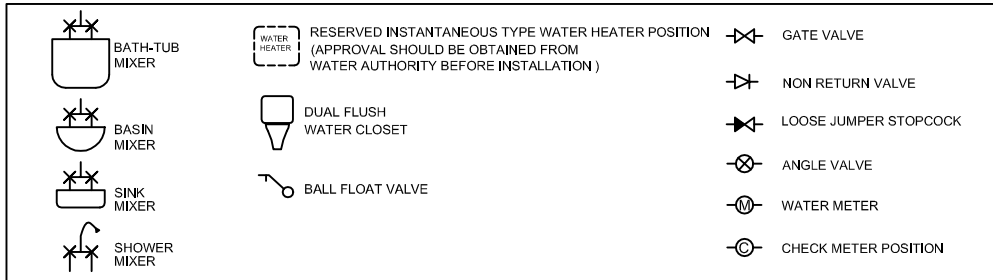

ADDRESS: _____

NOTES:

- 1/ FRESH WATER PIPE JOINTING METHOD: SOLDERING/COMPRESSION/OTHERS _____ (PLEASE SPECIFY)
 - 2/ NO WATER PIPE TO BE EMBEDDED IN LOAD BEARING STRUCTURAL ELEMENTS
 - 3/ ALL WATER PIPES WHICH COME INTO DIRECT CONTACT WITH CONCRETE TO BE PROTECTED WITH SUITABLE MATERIAL
 - 4/ FRESH WATER PIPE USING COPPER TUBE $\phi 15 - \phi 28$
 - 5/ FLUSHING WATER PIPE(TMFW) USING U.P.V.C $\phi 15 - \phi 50$
 - 6/ ALL PIPEWORK BEFORE METER POSITION SHALL BE EXPOSED OR LAID IN A PROPER SERVICE DUCT.
 - 7/ THE PIPINGS WHICH SOLELY SERVE A PARTICULAR FLAT/UNIT SHOULD NOT RUN THROUGH OTHER FLATS/UNITS AS FAR AS PRACTICABLE
- * A LOOSE JUMPER TYPE VALVE SHALL BE FITTED ON THE INLET OF THE WATER HEATER IF A NON-RETURN VALVE IS NOT INCORPORATED IN SUCH WATER HEATER, BUT THIS REQUIREMENT DOES NOT APPLY TO AN ELECTRIC WATER HEATER OF THE THERMAL STORAGE TYPE SATISFYING THE REQUIREMENTS STIPULATED IN THE HONG KONG STANDARD REQUIREMENTS FOR PLUMBING INSTALLATION IN BUILDINGS PARAGRAHPS 5.11

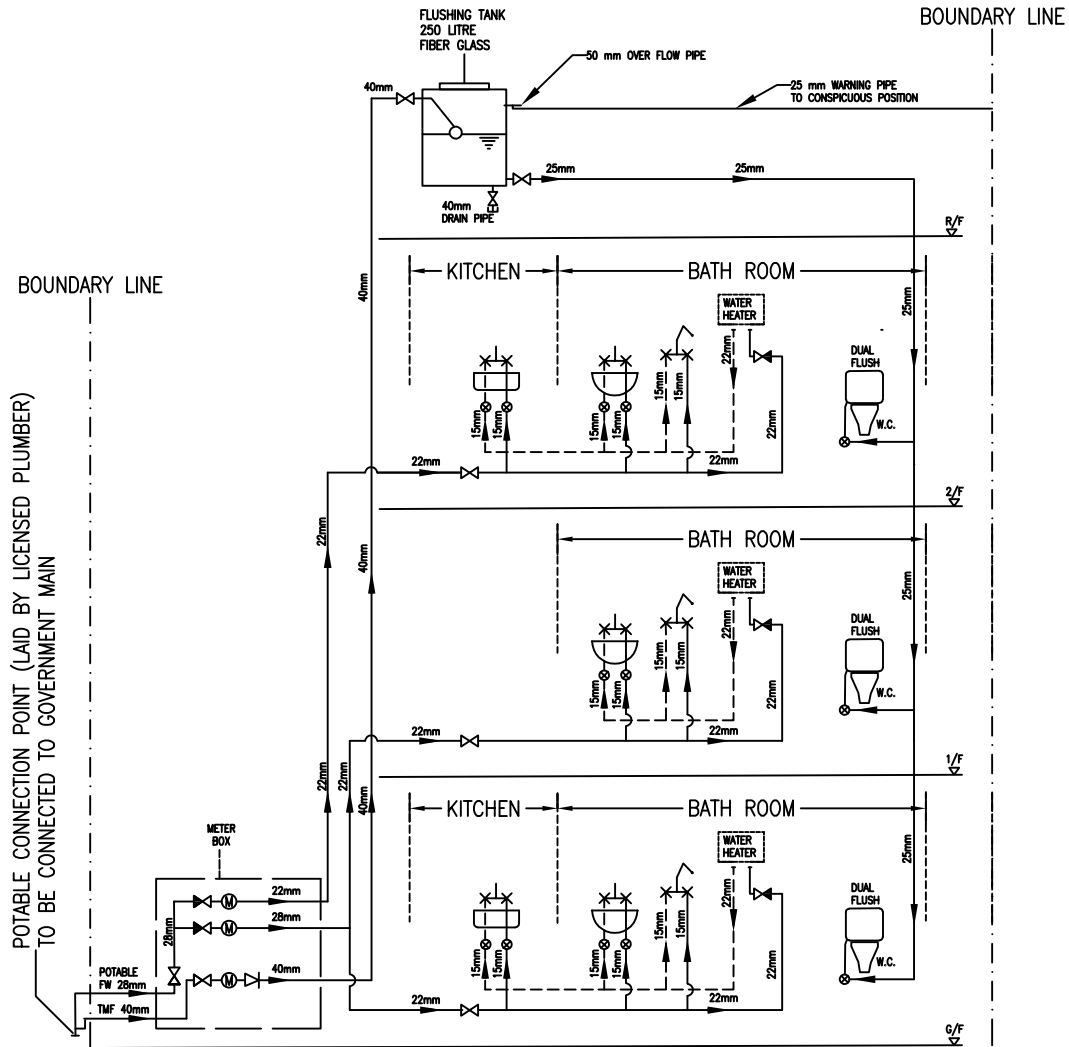

LEGEND:

	BATH-TUB MIXER		RESERVED INSTANTANEOUS TYPE WATER HEATER POSITION (APPROVAL SHOULD BE OBTAINED FROM WATER AUTHORITY BEFORE INSTALLATION)		GATE VALVE
	BASIN MIXER		DUAL FLUSH WATER CLOSET		NON RETURN VALVE
	SINK MIXER		BALL FLOAT VALVE		LOOSE JUMPER STOPCOCK
	SHOWER MIXER		ANGLE VALVE		WATER METER
			CHECK METER POSITION		

SPD.2

ADDRESS: _____

NOTES:

- 1/ FRESH WATER PIPE JOINTING METHOD: SOLDERING / COMPRESSION / OTHERS _____
(PLEASE SPECIFY)
- 2/ NO WATER PIPE TO BE EMBEDDED IN LOAD BEARING STRUCTURAL ELEMENTS
- 3/ ALL WATER PIPES WHICH COME INTO DIRECT CONTACT WITH CONCRETE TO BE PROTECTED WITH SUITABLE MATERIAL
- 4/ FRESH WATER PIPE USING COPPER TUBE $\varnothing 15 - \varnothing 28$
- 5/ FLUSHING WATER PIPE (TMF) USING U.P.V.C. $\varnothing 15 - \varnothing 50$
- 6/ ALL PIPEWORK BEFORE METER POSITION SHALL BE EXPOSED OR LAID IN A PROPER SERVICE DUCT
- 7/ THE PIPINGS WHICH SOLELY SERVE A PARTICULAR FLAT/UNIT SHOULD NOT RUN THROUGH OTHER FLATS/UNITS AS FAR AS PRACTICABLE

* A LOOSE JUMPER TYPE VALVE SHALL BE FITTED ON THE INLET OF THE WATER HEATER IF A NON-RETURN VALVE IS NOT INCORPORATED IN SUCH WATER HEATER, BUT THIS REQUIREMENT DOES NOT APPLY TO AN ELECTRIC WATER HEATER OF THE THERMAL STORAGE TYPE SATISFYING THE REQUIREMENTS STIPULATED IN THE HONG KONG STANDARD REQUIREMENTS FOR PLUMBING INSTALLATION IN BUILDINGS PARAGRAPHS 5.11

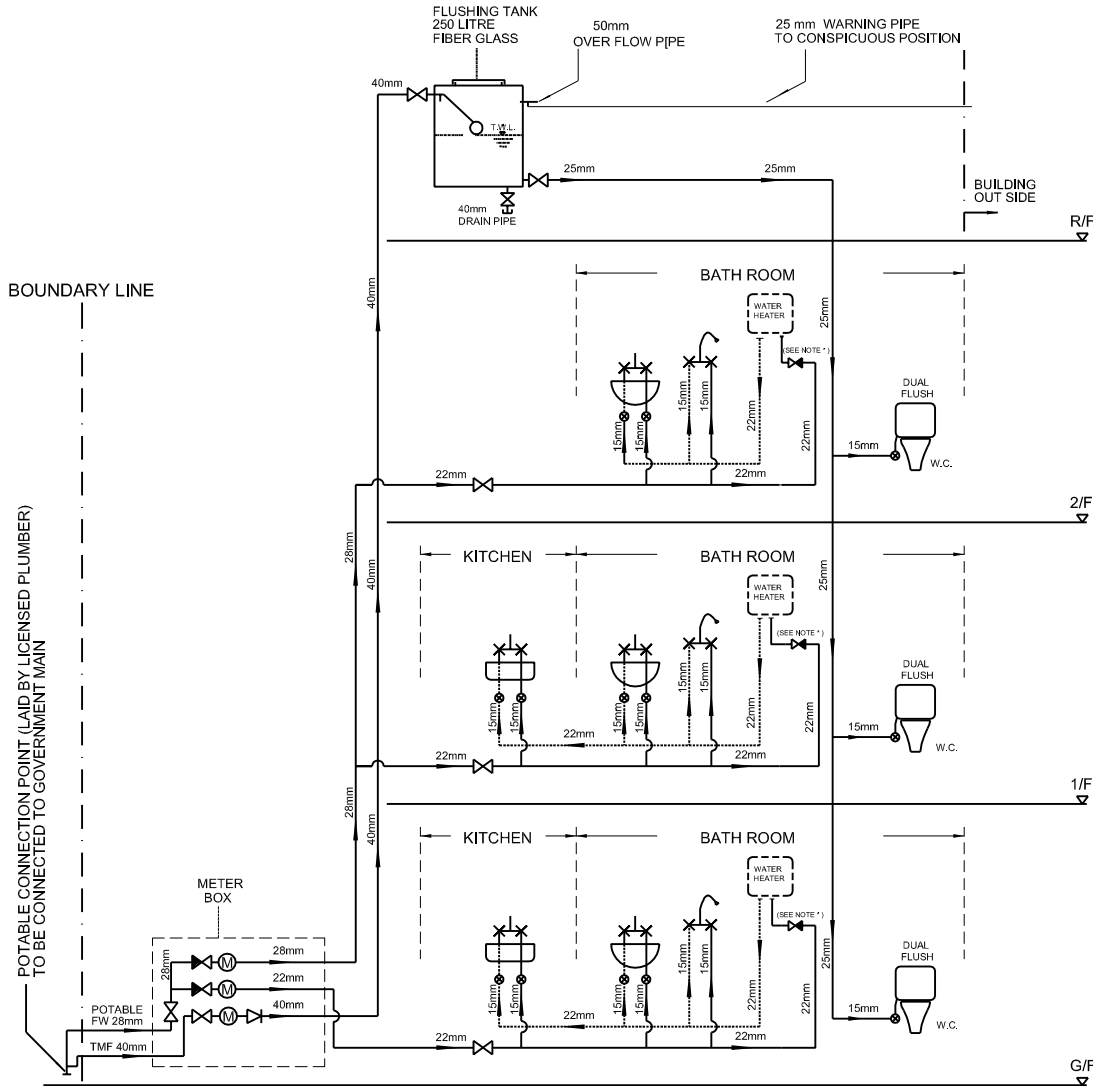

LEGEND:

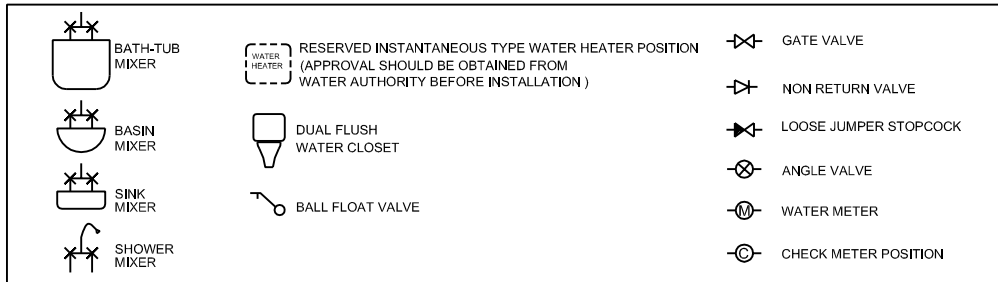

ADDRESS: _____

NOTES:

- 1/ FRESH WATER PIPE JOINTING METHOD: SOLDERING / COMPRESSION / OTHERS _____
(PLEASE SPECIFY)
- 2/ NO WATER PIPE TO BE EMBEDDED IN LOAD BEARING STRUCTURAL ELEMENTS
- 3/ ALL WATER PIPES WHICH COME INTO DIRECT CONTACT WITH CONCRETE TO BE PROTECTED WITH SUITABLE MATERIAL
- 4/ FRESH WATER PIPE USING COPPER TUBE $\varnothing 15 - \varnothing 28$
- 5/ FLUSHING WATER PIPE (TMF) USING U.P.V.C. $\varnothing 15 - \varnothing 50$
- 6/ ALL PIPEWORK BEFORE METER POSITION SHALL BE EXPOSED OR LAID IN A PROPER SERVICE DUCT
- 7/ THE PIPINGS WHICH SOLELY SERVE A PARTICULAR FLAT/UNIT SHOULD NOT RUN THROUGH OTHER FLATS/UNITS AS FAR AS PRACTICABLE

* A LOOSE JUMPER TYPE VALVE SHALL BE FITTED ON THE INLET OF THE WATER HEATER IF A NON-RETURN VALVE IS NOT INCORPORATED IN SUCH WATER HEATER, BUT THIS REQUIREMENT DOES NOT APPLY TO AN ELECTRIC WATER HEATER OF THE THERMAL STORAGE TYPE SATISFYING THE REQUIREMENTS STIPULATED IN THE HONG KONG STANDARD REQUIREMENTS FOR PLUMBING INSTALLATION IN BUILDINGS PARAGRAPHS 5.11

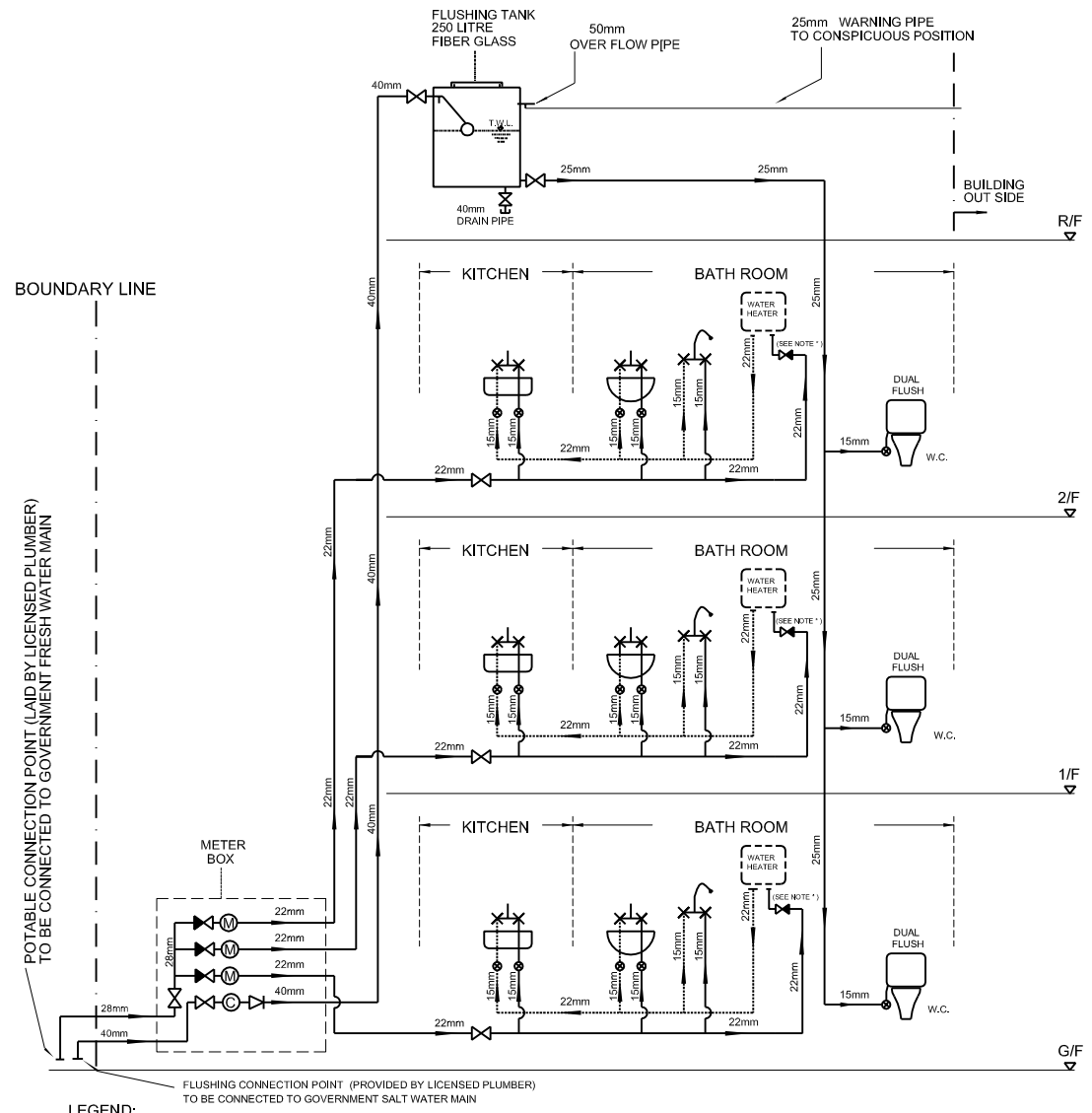

LEGEND:

	BATH-TUB MIXER		RESERVED INSTANTANEOUS TYPE WATER HEATER POSITION (APPROVAL SHOULD BE OBTAINED FROM WATER AUTHORITY BEFORE INSTALLATION)		GATE VALVE
	BASIN MIXER		DUAL FLUSH WATER CLOSET		NON RETURN VALVE
	SINK MIXER		BALL FLOAT VALVE		LOOSE JUMPER STOPCOCK
	SHOWER MIXER		ANGLE VALVE		WATER METER
			CHECK METER POSITION		

ADDRESS: _____

NOTES:

- 1/ FRESH WATER PIPE JOINTING METHOD: SOLDERING / COMPRESSION / OTHERS _____
(PLEASE SPECIFY)
- 2/ NO WATER PIPE TO BE EMBEDDED IN LOAD BEARING STRUCTURAL ELEMENTS
- 3/ ALL WATER PIPES WHICH COME INTO DIRECT CONTACT WITH CONCRETE TO BE PROTECTED WITH SUITABLE MATERIAL
- 4/ FRESH WATER PIPE USING COPPER TUBE Ø15 - Ø28
- 5/ FLUSHING WATER PIPE (TMF) USING U.P.V.C. Ø15 - Ø50
- 6/ ALL PIPEWORK BEFORE METER POSITION SHALL BE EXPOSED OR LAID IN A PROPER SERVICE DUCT
- 7/ THE PIPINGS WHICH SOLELY SERVE A PARTICULAR FLAT/UNIT SHOULD NOT RUN THROUGH OTHER FLATS/UNITS AS FAR AS PRACTICABLE

* A LOOSE JUMPER TYPE VALVE SHALL BE FITTED ON THE INLET OF THE WATER HEATER IF A NON-RETURN VALVE IS NOT INCORPORATED IN SUCH WATER HEATER, BUT THIS REQUIREMENT DOES NOT APPLY TO AN ELECTRIC WATER HEATER OF THE THERMAL STORAGE TYPE SATISFYING THE REQUIREMENTS STIPULATED IN THE HONG KONG STANDARD REQUIREMENTS FOR PLUMBING INSTALLATION IN BUILDINGS PARAGRAPHS 5.11

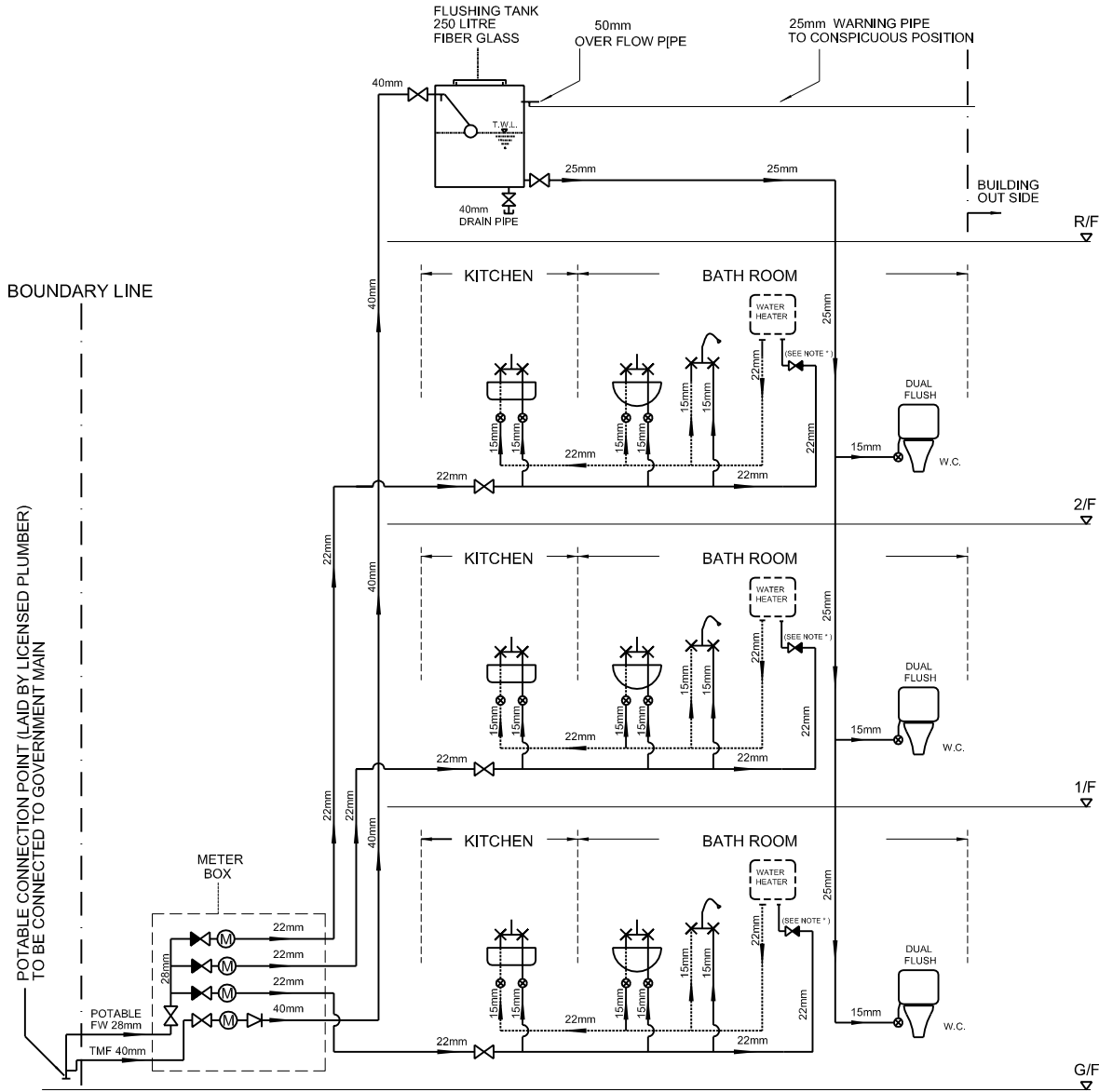

LEGEND:

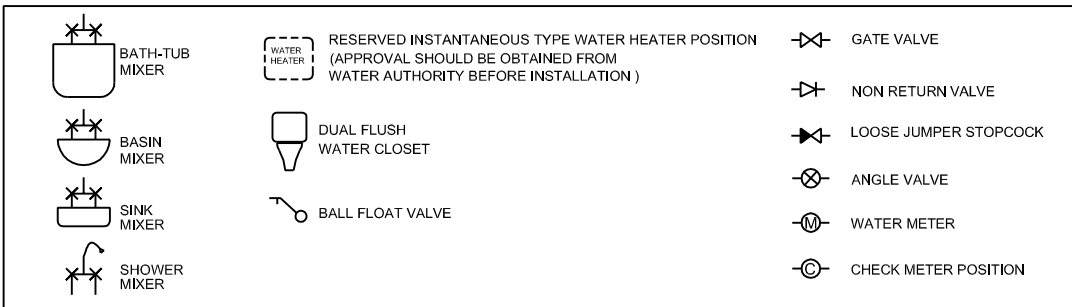

SPD.5

ADDRESS: _____

NOTES:

- 1/ FRESH WATER PIPE JOINTING METHOD: SOLDERING/COMPRESSION/OTHERS _____ (PLEASE SPECIFY)
 - 2/ NO WATER PIPE TO BE EMBEDDED IN LOAD BEARING STRUCTURAL ELEMENTS
 - 3/ ALL WATER PIPES WHICH COME INTO DIRECT CONTACT WITH CONCRETE TO BE PROTECTED WITH SUITABLE MATERIAL
 - 4/ FRESH WATER PIPE USING COPPER TUBE $\phi 15 - \phi 28$
 - 5/ FLUSHING WATER PIPE(TMf) USING U.P.V.C $\phi 15 - \phi 50$
 - 6/ ALL PIPEWORK BEFORE METER POSITION SHALL BE EXPOSED OR LAID IN A PROPER SERVICE DUCT.
 - 7/ THE PIPINGS WHICH SOLELY SERVE A PARTICULAR FLAT/UNIT SHOULD NOT RUN THROUGH OTHER FLATS/UNITS AS FAR AS PRACTICABLE
- * A LOOSE JUMPER TYPE VALVE SHALL BE FITTED ON THE INLET OF THE WATER HEATER IF A NON-RETURN VALVE IS NOT INCORPORATED IN SUCH WATER HEATER, BUT THIS REQUIREMENT DOES NOT APPLY TO AN ELECTRIC WATER HEATER OF THE THERMAL STORAGE TYPE SATISFYING THE REQUIREMENTS STIPULATED IN THE HONG KONG STANDARD REQUIREMENTS FOR PLUMBING INSTALLATION IN BUILDINGS PARAGRAHPS 5.11

Please "✓" as appropriate	KITCHEN			BATHROOM1			BATHROOM2		
	YES WITH WATER HEATER	YES WITHOUT WATER HEATER	NOT APPLI-CABLE	YES WITH WATER HEATER	YES WITHOUT WATER HEATER	NOT APPLI-CABLE	YES WITH WATER HEATER	YES WITHOUT WATER HEATER	NOT APPLI-CABLE
2/F									
1/F									
G/F									

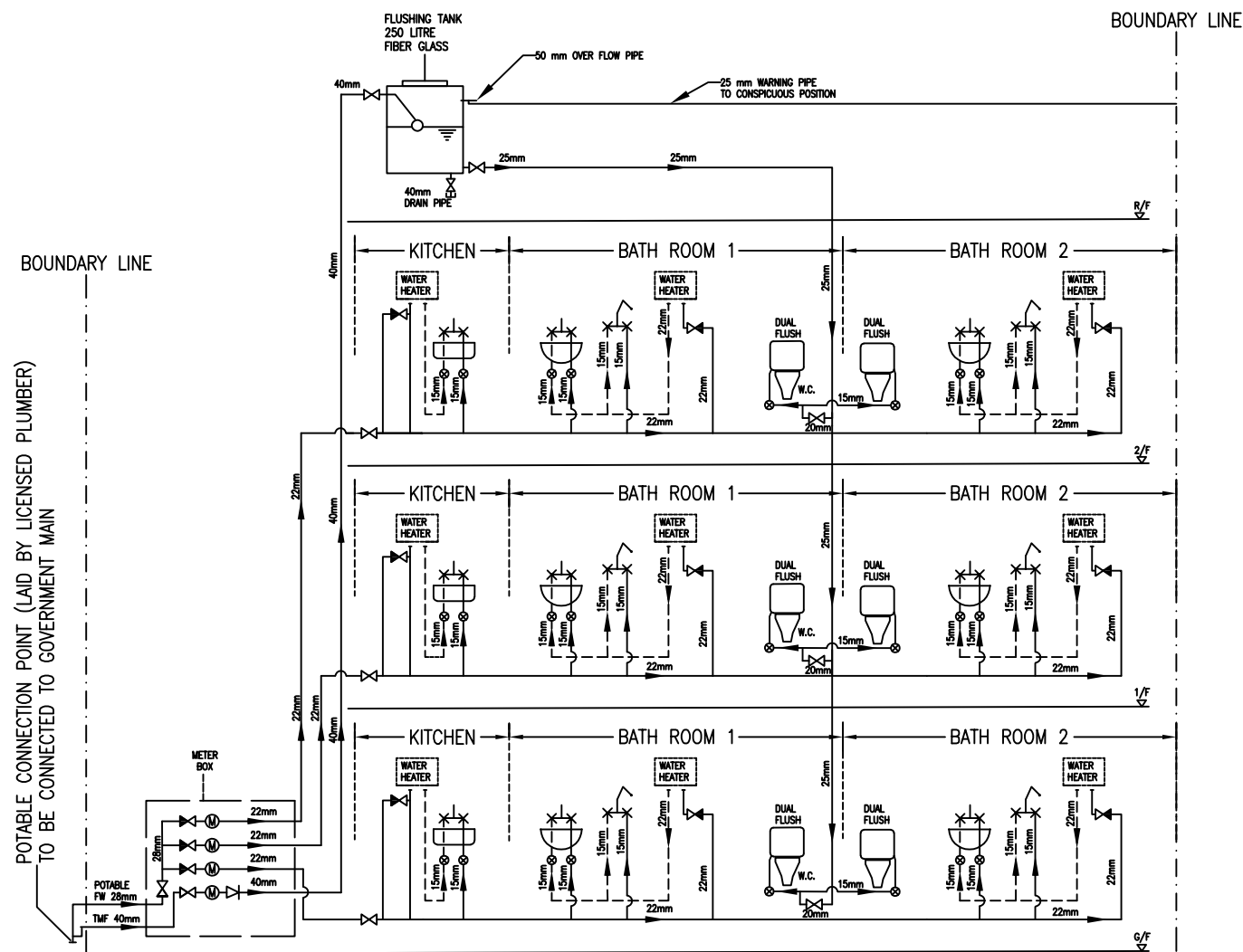

LEGEND:

